



[www.copyquality.com](http://www.copyquality.com)

# KIP 2300

## HIGH PRODUCTION CCD SCAN SYSTEM



# KIP 2300 CCD SCANNING SYSTEM

## High Production Scan System

The new KIP 2300 high productivity scanner sets a uniquely high standard for speed, quality and flexibility in a digital image capture system.

Best in class productivity is achieved by a combination of advanced camera based image capture and new KIP Tru•Speed Technology for high speed data throughput with no system pauses or slow downs.

Outstanding image quality is delivered through the innovative use of bright white LED light sources for illumination and 600 x 600 dpi image capture resolution.

The KIP 2300 is a high speed scan solution that provides world-class workflow flexibility through its ability to scan face up or face down and scan thick mounted originals and loose sheets of paper from a single unit.

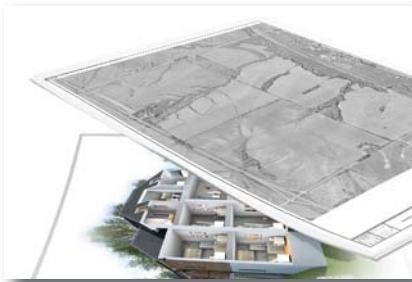

## Versatile Camera Imaging

The KIP 2300 Color Scanner Solution can support both monochrome and color scan-to-file and copy to satisfy most application needs. When scanning to file, users have advanced software controls over image quality; when copying, a closed loop calibration system adjusts output to the exact inkjet device being used for output, ensuring maximum copy quality.

The KIP 2300 scanner is powerful, with image capture speeds from 5 ips to 15 ips in monochrome (dependent on dpi) and 2 to 6 ips in color. The image capture area is up to 36 in. wide, yet originals up to 42 in. wide may be fed through the scanner.

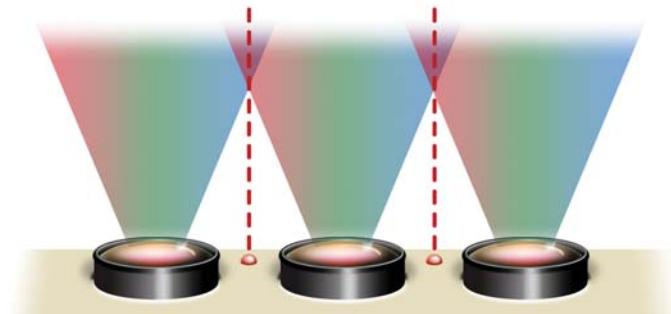

*Three independent imaging cameras with an advanced laser alignment system and self-calibrating diagnostics provide an extraordinary level of quality.*



## Flexible Scan System

600 dpi optical resolutions is the key to the KIP 2300 Color Scanner's outstanding imaging capabilities. In addition, the KIP 2300 Color Scanner takes full advantage of patented (Real Time Thresholding) and self calibrating imaging cameras to ensure high quality results.

To optimize image size for intended use, users can select custom resolutions, for example 72 dpi for website and PC monitor displays and 300 for offset press work.

## KIP Tru•Speed Technology

The technology used in KIP Tru•Speed scanning provides an image data transfer rate of 2.3 GB per second, ensuring high productivity for the most complex full color documents. Originals are imaged at maximum speed with no scanning slowdowns or pauses, as found in all competitive scanning systems. KIP Tru•Speed scanning delivers full color, high speed imaging for the most demanding production environments.



- **Faster than any other competing image transfer technology**
- **190 times faster than USB 1.0!**
- **4.8 times faster than USB 2.0!**
- **2.9 times faster than Firewire!**
- **Scan documents at full speed and full resolution**
- **No scanning pauses or slow downs**

# KIP COLOR PRO



## KIP Color Pro

KIP Color Pro software provides all the features of KIP Color Advanced, plus file to print, professional ICC color management, image editing capabilities, paneling of images for outdoor graphics, nesting of images for optimum media usage and much more.

- Supports a full range of color file formats
- Create, edit & save image quality filters
- Integrates with single or multiple printers
- Accurate color from closed-loop calibration
- Scan to email, USB drives, mailboxes or network
- Professional grade image enhancement options
- Expert mode printing features
- Black point and white point adjustments
- Sharpness and scan speed control
- Image editor with deskew and cropping

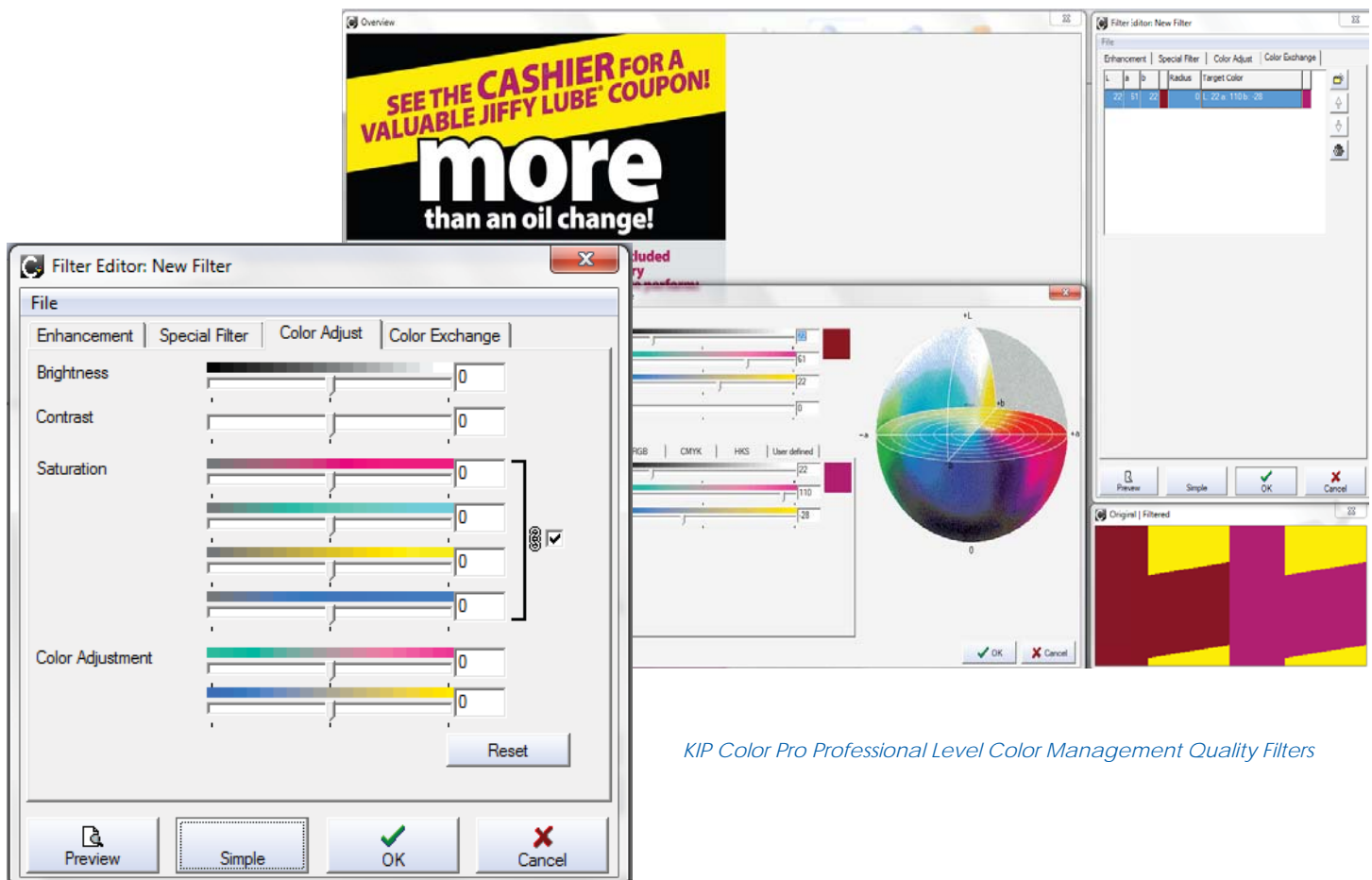

*KIP Color Pro Professional Level Color Management Quality Filters*





Copy, Print & Scan



Professional Image Editor



Copy & Print Paneling

KIP Color Pro Features	B&W	Color
Single and Collated Sets Copying	•	•
Mixed Mono and Color Copying	•	•
Scale By Factor, Page Size, Auto	•	•
Image Preview	•	•
Auto Image Deskew	•	•
Area of Interest Reduce/Enlarge	•	•
Auto Start for Fast Document Feeding	•	•
Copy to all KIP printers	•	•
Concurrent Copy and Print	•	•
Scan to File & Copy In Parallel	•	•
Professional Grade Copy Filter Editor and Preview	•	•
KIP Cost Review Application Integration	•	•
KIP Track System	•	•
<b>Scan Features</b>		
Auto Detect Original Size	•	•
Scan Area of Interest / Scan to Specific Size	•	•
Wide Variety of Formats	•	•
Scan to Email (Full Image or Area of Interest)	•	•
Mono / Grayscale / Color Scanning	•	•
Scan to Multipage PDF and TIF	•	•
Scan Image Compression (Variable)	•	•
Graphics Viewer/Editor for Despeckle/Deskew	•	•
Auto Increment of File Name	•	•
<b>File to Print Features</b>		
Print Single or Multiple Files to KIP or Inkjet	•	•
Paneling	•	•
KIP Printer Linearizations	•	•
Spot Color Exchange	•	•
Nesting (Step and Repeat)	•	•
On Screen Softproof Capability	•	•
<b>Copy Features</b>		
Color Adjustment		•
Paneling	•	•
Roll Preview	•	•
Gamut Warning and On Screen Softproof	•	•

KIP Color Pro Features	B&W	Color
<b>Copy Features</b>		
Multicopy Nesting	•	•
Set Black and White Point at Start of Set	•	•
Media Calibration Wizard	•	•
Job Editor to Mix Copy, Scan and File Images	•	•
Reprint	•	•
Nesting (Step and Repeat)	•	•
Printer/Scanner Closed Loop Calibration	•	•
Unlimited Presets/Templates	•	•
<b>Professional Copy Filter Editor</b>		
Adjust Scan/Copy Resolution	•	•
Adaptive Black Point By Auto or User Selection	•	•
Adaptive White Point By Auto or User Selection	•	•
Black Enhancement	•	•
Background Removal	•	•
Included Printer Drivers for 1 KIP, 2 Inkjets	•	•
Additional KIP and Inkjet Drivers	Optional	Optional
<b>Scan Features</b>		
Scan to File	•	•
Scan to File - File formats	All Types	All Types
Color Adjustment		•
Grayscale Adjustment	•	•
Background Processing	•	•
Import Color Profiles		•
Scan at Faster Speeds at Lower DPI	•	•
Control Scanner Speed Independent of DPI	•	•
Supports PDF Security Protocols	•	•
Unlimited Presets/Templates	•	•
Professional Scan Filter Editor and Preview	•	•
Adjust Scan/Copy Resolution	•	•
Adaptive Black Point By Auto or User Selection	•	•
Adaptive White Point By Auto or User Selection	•	•
Scan B&W Images Using Color Data	•	•
Twain Support	•	•
Graphics Editor and Preview	•	•
Despeckle and Hole Fill	•	

• = New/Enhanced available in latest version

# KIP 2300 SPACE REQUIREMENTS

## KIP 2300 Scanning System Space Requirements

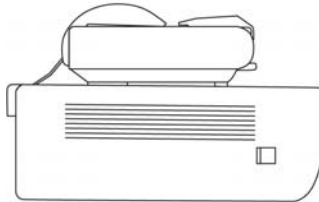

**KIP 2300 Side View**

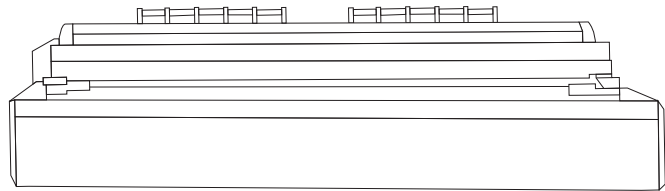

**KIP 2300 Front View**

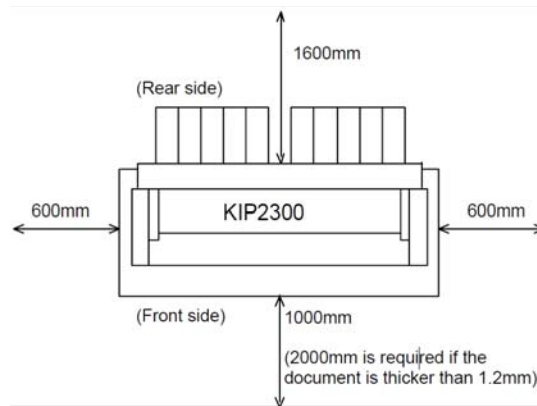

**KIP 2300 Top View**

# KIP 2300 SPECIFICATIONS

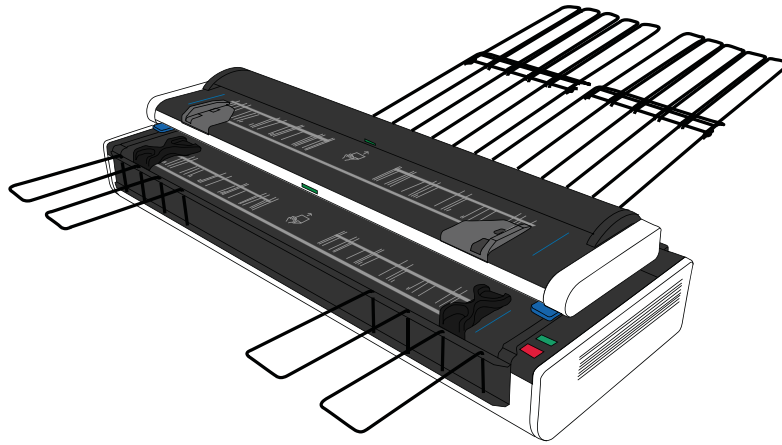

General	
Scanner Type	C.C.D. with KIP Tru•Speed Technology and KIP RTT Technology
Scan Resolution	600 x 600 dpi optical resolution
Scan Speed	Up to 60 ft / 18 m per minute (Mono), Up to 30 ft / 9 m per minute (Color)
Scan Formats	TIFF, Multipage TIFF, PDF, PDF-A, Multipage PDF, DWF, Multipage DWF, JPEG, CALS
Scan Destination	Local USB (Removable Media), Unlimited IPS Mailboxes (Local), Unlimited FTP, Unlimited SMB
Original Size Width/Length	Originals Up to 42" - 36" / 1,066 mm - 914 mm Scan width
Original Thickness	Up to .6" / 16 mm Automatic thickness detection
Original Face Up/Face Down	Both - Dual Original Feed Tables
Interface	USB 2.0, KIP Tru•Speed Technology (2.3GB per sec data transfer)
Dimensions	55" W x 21" D x 11" H / 1,399 mm W, 480 mm D, 310 mm H
Weight	160 lbs / 73 kg
Electrical	100-240V AC 50/60 Hz
Power Consumption	< 120 W
Minimum PC Requirements (NOT INCLUDED WITH SCANNER)	<p>Quad Core Processor ( such as an Intel i5 or higher )</p> <p>Windows XP / 7 / 8 (32 or 64 bit version)</p> <p>8GB RAM with 64 bit or 3GB RAM 32 bit</p> <p>1 TB Hard Drive</p> <p>1 Gig RJ45 LAN Port</p> <p>DVD/CD Optical Drive</p> <p>One USB 2.0 Port for KIP Color Advanced / Pro (scanner connection)</p> <p>One PCI-E Port (for use with the KIP Tru•Speed Card (HIL) for KIP 2300)</p> <p>One USB 2.0 Port for KIP RIP (product code connection)</p> <p>20" Flat panel monitor (with VESA - 75 or 100 mount patterns for use with a KIP scanner stand)</p> <p>USB keyboard and mouse</p>



9525 Harford Road  
Baltimore, MD 21234  
410-337-3700

[info@copyquality.com](mailto:info@copyquality.com)

KIP is a registered trademark of the KIP Group. All other product names mentioned herein are trademarks of their respective companies. All product features and specifications are subject to change without notice. Complete product specifications are available upon request. © 2012

